



Version 1.3v-01/2020
Print-No. 01

Verderflex Rollit 19 - 35 TH

Rollit 19-35 TH Spare Parts List

Table 1 contains a list of spares to help maintain and repair the Rollit 19-35 TH peristaltic pumps. Your Verder distributor will be able to advise you where genuine Verderflex® spares can be purchased.

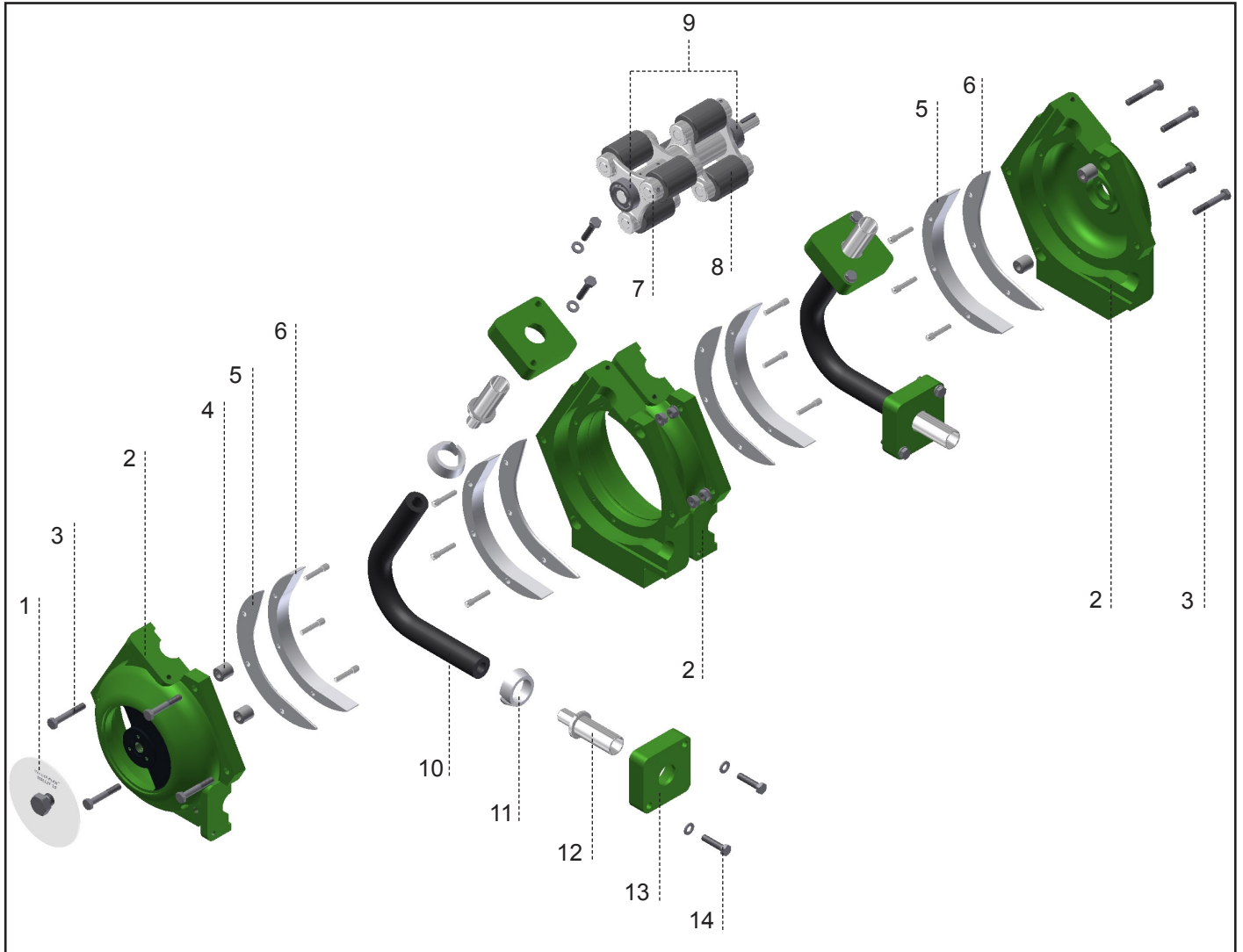

Figure 2 Layout (generic view)

- | | | | | | |
|---|------------------|----|-------------------------|----|-------------------------|
| 1 | Casing cover | 6 | Teflon inserts complete | 11 | Clamping ring |
| 2 | Pump casing | 7 | Rotor complete | 12 | Hose tail |
| 3 | Casing fasteners | 8 | Rollers complete | 13 | Counter flange |
| 4 | Centering piece | 9 | Bearing | 14 | Counter flange fastener |
| 5 | Guide rails | 10 | Pump hose | | |

Table 1 Rollit 19-35 TH Spare Parts List







Ref	Item	Part No		Qty	Image
1	Casing cover Plexiglass <i>(for Casing Cover SS Meets Atex see Table 1.1)</i>	R 19 TH	114.100127	1	
		R 30 TH	114.100128		
		R 35 TH	114.100034		
3	Casing fasteners	R 19 TH	M8 x 50 Steel BZP	4	
		R 30 TH	M8 x 50 Steel BZP		
		R 35 TH	M8 x 60 Steel BZP		
4	Centering piece <i>Set of 2 Pieces</i>	R 19 TH	-	1	
		R 30 TH	-		
		R 35 TH	-		
5	Guide rails <i>Set of 4 Pieces (for Guide rails Meets Atex see Table 1.1)</i>	R 19 TH	114.100088	1	
		R 30 TH	114.100089		
		R 35 TH	114.100129		
6	Teflon inserts complete <i>Set of 4 Pieces (for Teflon inserts Meets Atex see Table 1.1)</i>	R 19 TH	114.100079	1	
		R 30 TH	114.100080		
		R 35 TH	114.100081		
7	Rotor complete	R 19 TH	114.100112	1	
		R 30 TH	114.100113		
		R 35 TH	114.100114		
8	Rollers complete Set <i>Set of 6 Pieces</i>	R 19 TH	114.100115	1	
		R 30 TH	114.100116		
		R 35 TH	114.100117		

Table 1 Rollit 19-35 TH Spare Parts List (continued)



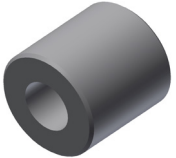

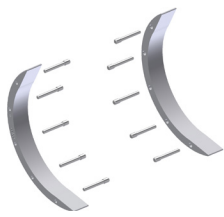
Ref	Item	Part No			Qty	Image
9	Bearing Set of 2 Pieces	R 19 TH	114.100068		1	
		R 30 TH	114.100069			
		R 35 TH	114.100070			
11	Clamping ring	R 19 TH	114.100109		1	
		R 30 TH	114.100110			
		R 35 TH	114.100111			
12	Hose tail	R 19 TH nominal size 25	PP	114.100104	1	
			SS 1.4571	114.100107		
		R 30 TH nominal size 31	PP	114.100043		
			SS 1.4571	114.100048		
		R 35 TH nominal size 51	PP	114.100105		
			SS 1.4571	114.100108		
12.1	Hose tail with tread DIN ISO 228	R 19 TH nominal size 3/4"	SS 1.4571	on request	1	
		R 30 TH nominal size 1"	SS 1.4571	on request		
		R 35 TH nominal size 1 1/2"	SS 1.4571	on request		
12.2	Hose tail with tread NPT	R 19 TH nominal size 3/4"	SS 1.4571	on request	1	
		R 30 TH nominal size 1"	SS 1.4571	on request		
		R 35 TH nominal size 1 1/2"	SS 1.4571	on request		

Table 1 Rollit 19-35 TH Spare Parts List (continued)







Ref	Item	Part No			Qty	Image
12.3	Hose tail with tread BSPT	R 19 TH nominal size 3/4"	SS 1.4571	on request	1	
		R 30 TH nominal size 1"	SS 1.4571	on request		
		R 35 TH nominal size 1 1/2"	SS 1.4571	on request		
13	Counter flange Set of 2 pieces	R 19 TH	on request		1	
		R 30 TH	on request			
		R 35 TH	on request			
13.1	Thread flange DIN 2633	R 19 TH nominal size DN 20	SS 1.4571	on request	1	
		R 30 TH nominal size DN 25	SS 1.4571	on request		
		R 35 TH nominal size DN 40	SS 1.4571	on request		
13.2	Thread flange ANSI B 16.5 150 lbs	R 19 TH nominal size 3/4"	SS 1.4571	on request	1	
		R 30 TH nominal size 1"	SS 1.4571	on request		
		R 35 TH nominal size 1 1/2"	SS 1.4571	on request		
14	Counter flange fastener: - bolt and washer	R 19 TH	M8 x 35 Steel BZP		4	
		R 30 TH	M10 x 50 Steel BZP			
	Counter flange fastener: - bolt, washer and nut.	R 35 TH	M12 x 65 Steel BZP			

Table 1.1 Rollit 15-35 TH Spare Parts List Meets Atex

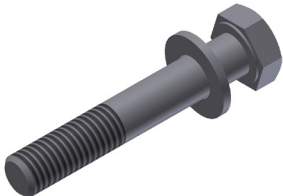

Ref	Item	Part No		Qty	Image
1	Casing cover SS Meets Atex	R 19 TH	114.100037	1	
		R 30 TH	114.100038		
		R 35 TH	114.100039		
5	Guide rails Meets Atex Set of 2 Pieces	R 19 TH	114.100088.Y	1	
		R 30 TH	114.100089.Y		
		R 35 TH	114.100129.Y		
6	Teflon inserts complete Meets Atex Set of 2 Pieces	R 19 TH	114.100079.Y	1	
		R 30 TH	114.100080.Y		
		R 35 TH	114.100081.Y		

Table 2 Rollit 19-35 H Hose options

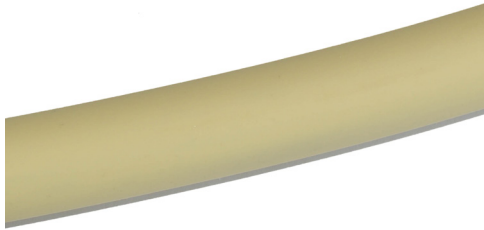
Item Description	Part No		Qty	Image
Hose options Ponnprene	R 19 H	114.100094	1	
	R 30 H	114.100095		
	R 35 H	114.100096		

Table 3 Rollit 19-35 TH Special Grease

Item Description	Part No	Qty
Rollit Special Grease	114.100072	250 gr.
	114.100106	1000 gr.