

**VERDERFLEX®**

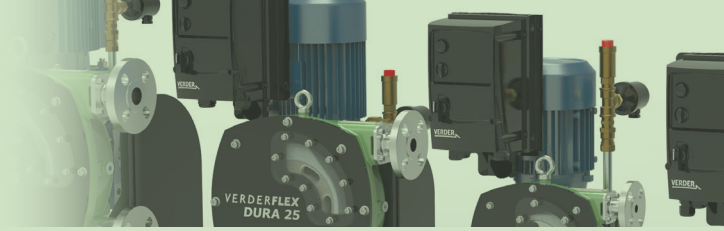

# Peristaltic Industrial Hose Pump

Supplementary  
Document

iDura  
5, 7, 10, 15, 25, 35

Version 1.0v-11/2020

Print-No. 01

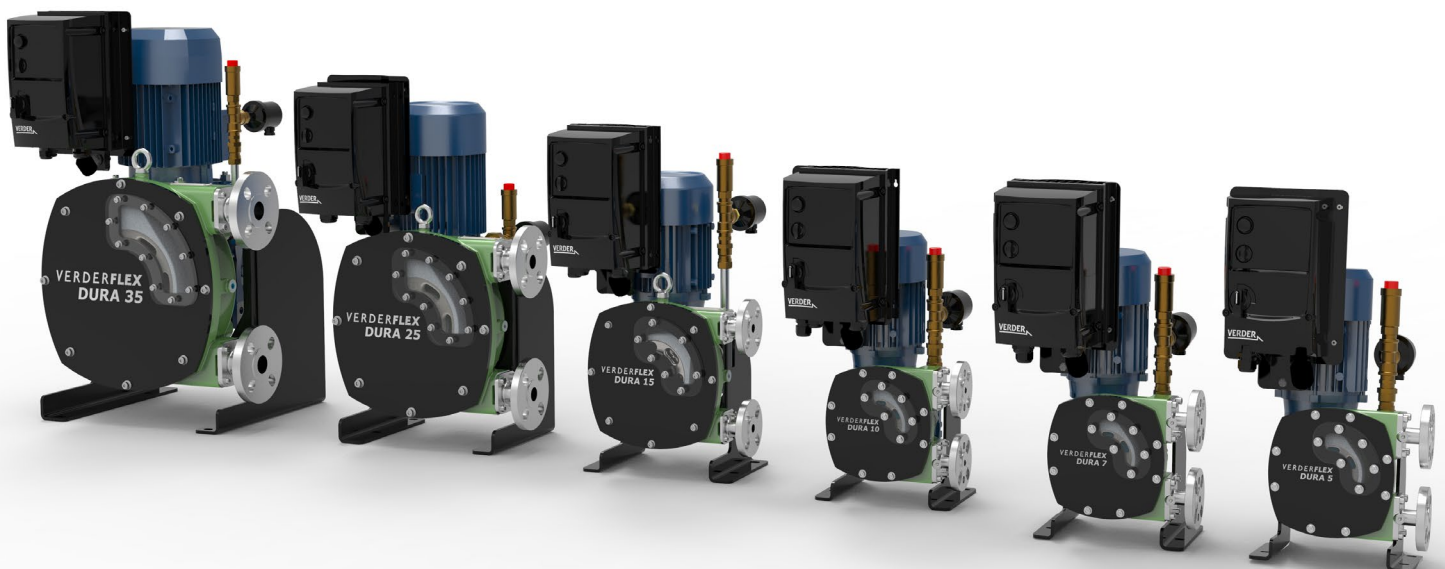

**VERDER**  
passion for pumps

Version 1.0v-11/2020  
Print-No. 01

**iDura**  
**5, 7, 10, 15, 25, 35**



The information in this document is essential for the safe operation of Verderflex® iDura pumps. This document must be read and understood thoroughly prior to installation of unit, electrical connection and commissioning.

# Table of Contents

- 1 About this Document**
  - 1.1 Target Groups
  - 1.2 Warnings and Symbols Used in the Manual
- 2 Safety**
  - 2.1 Intended Use
  - 2.2 General Safety Instructions
    - 2.2.1 Product Safety
    - 2.2.2 Obligation of the Operating Company
    - 2.2.3 Obligation of Personnel
  - 2.3 Specific Hazards
    - 2.3.1 Hazardous Pumped Liquids
    - 2.3.2 Lubricants
    - 2.3.3 Sharp Edges
- 3 Transport, Storage and Disposal**
  - 3.1 Transport
    - 3.1.1 Unpacking and Inspection on Delivery
    - 3.1.2 Lifting
  - 3.2 Storage Conditions
  - 3.3 Interim Storage After Using the Pump
  - 3.4 Interim Storage Before Using the Pump
  - 3.5 Disposal
- 4 Electrical Safety**
  - 4.1 Electrical Connection
  - 4.2 Electric Shock Hazard
  - 4.3 Connecting to the Power Supply
- 5 Operation (supplementary)**
- 6 Maintenance**
  - 6.1 Hose Change
    - 6.1.1 Draining Lubricant
    - 6.1.2 Hose Change Using Inverter
    - 6.1.3 Hose Change Manually
    - 6.1.4 Re-installing the Hose, Port Flanges, Lubricant Refill and Fitting the Inspection Window
- 7 Service and Inspection of Electrical Components**
- 8 Troubleshooting for the iDura (Inverter Range)**
  - 8.1 Hose Burst Detection and Vent Kit
  - 8.2 iDura Inverter Functionality
- 9 List of Figures and Tables**
  - 9.1 List of Figures
  - 9.2 List of Tables
- 10 EC Declaration of Conformity**
- Appendix A - iDura 05-35**
- 11 Technical Specifications**
  - 11.1 Pump Specifications
  - 11.2 Ambient conditions
  - 11.3 Tightening Torques
  - 11.4 Preservatives
  - 11.5 Cleaning Agents (After hose is removed)
  - 11.6 Lubricants
  - 11.7 Rotor Options
- 12 Trademarks**

# 1 About this Document

This manual is a guideline for qualified users for the safe operation and maintenance of Verderflex® iDura pumps. This is a supplementary document to the Dura operating manual and the Inverter instruction manual. The operating manuals must be read and understood both by the installing personnel and the responsible trained personnel / operators prior to following additional guidelines in this document.

Instructions in this manual should be read in conjunction with instructions and guidelines in pump, motor, gearbox and inverter operating manuals.

## 1.1 Target Groups

Target Groups	Duty
Operating Company	<ul style="list-style-type: none"> <li>▶ Keep this manual available at the operating site of the pump.</li> <li>▶ Ensure that personnel read and follow the instructions in this manual and any other applicable documents, especially all safety instructions and warnings.</li> <li>▶ Observe any additional rules and regulations referring to the system.</li> </ul>
Qualified personnel, fitter	<ul style="list-style-type: none"> <li>▶ Read, observe and follow this manual and the other applicable documents, especially all safety instructions and warnings.</li> </ul>

Table 1 Target Groups

## 1.2 Warnings and Symbols Used in the Manual





Warning	Risk Level	Consequences of disregard
	Immediate risk	Death, serious bodily harm
	Potential acute risk	Death, serious bodily harm
	Potential hazardous situation	Potential damage to the pump
	For information	Possible incorrect use/maintenance of pump

Table 2 Warnings Used in the Manual







Symbol	Meaning
	Safety warning sign in accordance with DIN 4844 - W9 <ul style="list-style-type: none"> <li>▶ Take note of all information highlighted by the safety warning sign and follow the instructions to avoid injury or death.</li> </ul>
	Instruction
	Multiple-step instructions
	Checklist
	Cross-reference
	Information

Table 3 Symbols Used in the Manual

## 2 Safety

 The manufacturer does not accept any liability for damage resulting from disregard of this documentation as well as instructions in pump, motor, gearbox and inverter manuals.

### 2.1 Intended Use

- ▶ Only use the pump to handle compatible fluids as recommended by the manufacturer (→ 11 Technical Specifications).
- ▶ Adhere to the operating limits.
- ▶ Consult the manufacturer regarding any other use of the pump.
- ▶ Inverters should be wired to the power supply before use and this should be completed only by qualified personal and in accordance with the provisions of EMC Directive and EC Machinery Directive 2006/42/EC.

#### Prevention of obvious misuse (examples)

- ▶ Note the operating limits of the pump with regard to temperature, pressure, flow rate, motor speed and frequency (→ 11 Technical Specifications).
- ▶ Do not operate the pump with any inlet/outlet valves closed
- ▶ Install the inverter as recommended in this manual, in conjunction with instructions in the pump, motor, gearbox and inverter instruction manuals. For example, the following are not allowed:
  - Installing the pump without proper support.
  - Installation in the immediate vicinity of extreme hot or cold sources.

### 2.2 General Safety Instructions

 Observe the following regulations before carrying out any work.

#### 2.2.1 Product Safety

- These operating instructions contain fundamental information which must be complied with during installation, operation and maintenance. Therefore this operating manual must be read and understood both by the installing personnel and the responsible trained personnel / operators prior to installation and commissioning, and it must always be kept easily accessible within the operating premises of the machine. Not only must the general safety instructions laid down in this chapter on “Safety” be complied with, but also the safety instructions outlined under specific headings.
- Operate the pump only if it and all associated systems are in good functional condition.
- Only use the pump and inverter as intended, fully aware of safety and risk factors involved and the instructions in this manual.
- Keep this manual and all other applicable documents complete, legible and accessible to personnel at all times.
- Refrain from any procedure or action that would pose a risk to personnel or third parties.

- In the event of any safety-relevant faults, shut down the pump immediately and have the malfunction corrected by qualified personnel.
- The installation of the pump must comply with the requirements of installation given in this manual and any local, national or regional health and safety regulations.
- The pump and drive unit must not be mounted in direct sunlight or exposed to rain without suitable shade cover which is well ventilated.

#### 2.2.2 Obligation of the Operating Company

##### Safety-conscious operation

- Ensure that the following safety aspects are observed and monitored:
  - Adherence to intended use
  - Statutory or other safety and accident-prevention regulations
  - Safety regulations governing the handling of hazardous substances if applicable
  - Applicable standards and guidelines in the country where the pump is operated
- Make personal protective equipment available pertinent to operation of the pump.

##### Qualified personnel

- Ensure that all personnel tasked with work on the pump have read and understood this manual and all other applicable documents, including the safety, maintenance and repair information, prior to use or installation of the pump.
- Organize responsibilities, areas of competence and the supervision of personnel.
- Have all work carried out by specialist technicians only.
- Ensure that trainee personnel are under the supervision of specialist technicians at all times when working with the pump.

##### Safety equipment

Provide the following safety equipment and verify its functionality:

- For hot, cold and moving parts: safety guarding should be provided by the operating company.
- For potential build up of electrostatic charge: ensure appropriate grounding if and when required.

## Warranty

The warranty is void if the customer fails to follow any Instruction, Warning or Caution in this document. Verder has made every effort to illustrate and describe the product in this document. Such illustrations and descriptions are however, for the sole purpose of identification and do not express or imply a warranty that the products are merchantable or fit for a particular purpose, or that the products will necessarily conform to the illustration or descriptions.

Obtain the manufacturer's approval prior to carrying out any modifications, repairs or alterations during the warranty period. Only use genuine parts or parts that have been approved by the manufacturer.

For further details regarding warranty, refer to terms and conditions.

### 2.2.3 Obligation of Personnel



It is imperative that the instructions contained in this manual are complied with by the operating personnel at all times.

- ▶ Pump and associated components:
  - Do not lean or step on them or use as climbing aid
  - Do not use them to support boards, ramps or beams
  - Do not use them as a fixing point for winches or supports
  - Do not de-ice using gas burners or similar tools
- ▶ Do not remove the safety guarding for hot, cold or moving parts during operation.
- ▶ Reinstall the safety equipment on the pump as required by regulations after any repair / maintenance work on the pump.

## 2.3 Specific Hazards

### 2.3.1 Hazardous Pumped Liquids

Follow the statutory safety regulations when handling hazardous pumped liquids (e.g. hot, flammable, poisonous or potentially harmful).

Use appropriate Personal Protective Equipment when carrying out any work on the pump.

### 2.3.2 Lubricants

Ensure that the lubricant and pumped liquid are compatible with each other. This is a precautionary measure in case of accidental hose burst whereby the pumped liquid comes in contact with the lubricant. (→ Refer datasheet for lubricant to ensure compatibility and also refer to (→ 11 Technical Specifications) for specific lubricant limitations)

### 2.3.3 Sharp Edges

Pump parts, such as the shims and impellers, can be sharp

- Use protective gloves when carrying out any work on the pump

### 3 Transport, Storage and Disposal

#### 3.1 Transport

 Always transport the pump in a stable position and ensure that the pump is securely attached to the pallet.

##### 3.1.1 Unpacking and Inspection on Delivery

1. Report any transport damage to the manufacturer/distributor immediately.
2. Retain the pallet if any further transport is required.

##### 3.1.2 Lifting

 **DANGER**

**Death or crushing of limbs can be caused by falling loads!**

1. Use lifting gear appropriate for the total weight to be transported.
2. Make sure the pump and accessories are lifted and moved by qualified lifting personnel equipped with suitable lifting gear.
3. Where lifting eye is available, fasten the lifting gear to the lifting eye as shown in the following illustration. The lifting eye is available for Dura 15, 25 and 35 only.
4. Do not stand under suspended loads.

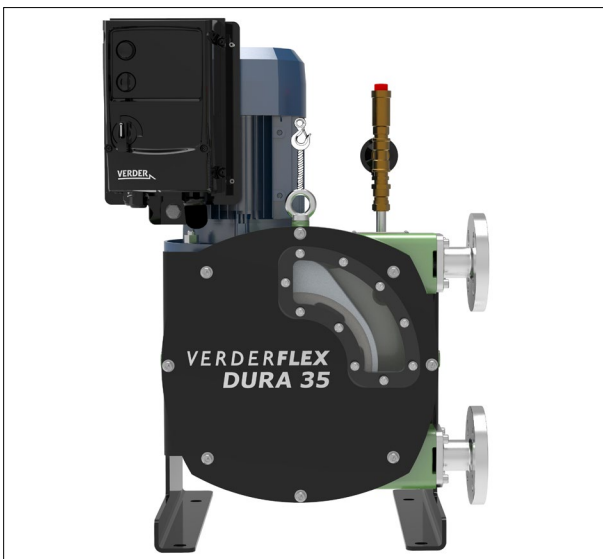

Figure 1 Fastening Lifting Gear to Pump

#### 3.2 Storage Conditions

1. Make sure the storage location meets the following conditions:
  - Dry, humidity not to exceed 85%, non-condensing
  - Out of direct sunlight
  - Frost-free; temperature range -5° to +45°C
  - Vibration-free
  - Dust-free
2. Depending on these conditions, it may be advisable to place a moisture-absorbing product, such as Silica gel, inside the pump's housing or to coat the pump's inner surfaces with moisture-repelling oil, such as WD40, whilst the pump is stored.
3. Hoses should be stored as supplied in their wrapper and should be stored away from direct sunlight, flat without any bends or kinks and at room temperature, with end caps fitted.
4. Lubricants should be stored under normal warehouse conditions with their caps securely fastened.
5. Gearboxes may require intermittent attention as indicated by the gearbox manufacturer's recommendations.

#### 3.3 Interim Storage After Using the Pump

- ▶ The hose should be removed from the pump.
- ▶ The pump housing lubricant should be drained.
- ▶ The pump housing should be washed out, allowed to dry and any external build up of product removed.

#### 3.4 Interim Storage Before Using the Pump

 **CAUTION**

**Pump damage caused by interim storage!**

- ▶ Allow the pump to reach ambient temperature before use.
- ▶ Please observe the storage recommendations and use by dates which apply to hose you may wish to bring into service after storage.

### 3.5 Disposal

With prolonged use, pump parts can be contaminated by hazardous pumped liquids to such an extent that cleaning may be insufficient.

 **WARNING**

**Risk of poisoning and environmental damage by the pumped liquid or oil!**

- ▶ Use suitable personal protective equipment when carrying out any work on the pump.
- ▶ Prior to disposal of the pump:
  - Drain and dispose the lubricant in accordance with local regulations.
  - Collect and dispose of any leaking pumped liquid or oil in accordance with local regulations.
  - Neutralize residues of pumped liquid in the pump.
- ▶ Dispose of the pump and associated parts in accordance with local regulations.

## 4 Electrical Safety

### 4.1 Electrical Connection

 **DANGER**

**Risk to health due to electric shock!**

- ▶ All electrical work must be carried out by qualified electricians.

**Death or crushing of limbs caused by falling loads!**

- ▶ Use lifting gear appropriate for the total weight to be transported.
- ▶ Do not stand under suspended loads.
- ▶ Ensure the travel plug is removed and disposed correctly before the motor and gearbox is attached to the pump.

### 4.2 Electric Shock Hazard

1. Disconnect and ISOLATE the Inverter before attempting any work on it.
2. High voltages are present at the terminals and within the drive for up to 10 minutes after disconnection of the electrical supply. Always ensure by using a suitable multimeter that no voltage is present on any drive power terminals prior to commencing any work.
3. Where supply to the drive is through a plug and socket connector, do not disconnect until 10 minutes have elapsed after turning off the supply.
4. Ensure correct earthing connections. The earth cable must be sufficient to carry the maximum supply fault current which normally will be limited by the fuses or MCB. Suitably rated fuses or MCB should be fitted in the mains supply to the drive, according to any local legislation or codes.
5. Ensure correct earthing connections and cable selection as per defined by local legislation or codes. The drive may have a leakage current of greater than 3.5mA; furthermore the earth cable must be sufficient to carry the maximum supply fault current which normally will be limited by the fuses or MCB.
6. Suitably rated fuses or MCB should be fitted in the mains supply to the drive, according to any local legislation or codes.
7. Do not carry out any work on the drive control cables whilst power is applied to the drive or to the external control circuits.

1. The Inverter uses high voltages and currents, carries a high level of stored electrical energy, and is used to control mechanical plant that may cause injury. Close attention is required to system design and electrical installation to avoid hazards in either normal operation or in the event of equipment malfunction.
2. Only qualified electricians are allowed to install and maintain this product.  
System design, installation, commissioning and maintenance must be carried out only by personnel who have the necessary training and experience. They must carefully read this safety information and the instructions in this Guide and follow all information regarding transport, storage, installation and use of the Inverter, including the specified environmental limitations.
3. Do not perform any flash test or voltage withstand test on the Inverter.
4. In order to protect inverter and motor from high voltage or transient damage, it is recommended to use suitable Surge Protection Device (SPD) when wiring the inverter.



### 4.3 Connecting to the Power Supply

 Select the correct specification of cable for connecting the inverter (→ Refer to the Invertek manual for cable installation guidance)

1. Remove the terminal cover from the inverter (Phillips screwdriver)
2. With power isolated, remove the plug in the gland and feed the supply cable through.
3. Connect earth to the closest earth point within the terminal cavity.
4. Connect phases as denoted by "A" in the Figure 2 Wiring Diagram - Single and 3 Phases Supply (varies on supply phase).
5. Terminal screw Torque values are provided in the Invertek manual supplied with the pump USB memory stick.
6. Check connections and glands are secure by tugging lightly on the cable.
7. Replace terminal cover and set isolator switch to 1. This will turn on the device and output connections may be live.
8. Check pump rotational direction matches up with the directional switch on the inverter, refer to → 5 Operation (supplementary).

## CAUTION

If pump turns in opposite direction to switch, change a pair of motor phases will change motor direction (e.g. switching connection of cable in terminal U to terminal V. Ensure that inverter is isolated from the electrical supply.

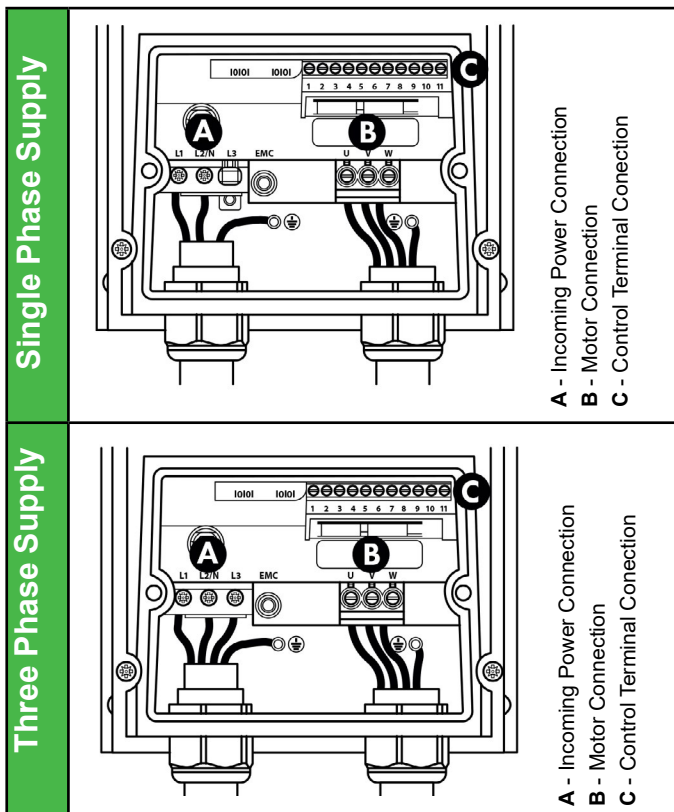

Figure 2 Wiring Diagram - Single and 3 Phases Supply

### 5 Operation (supplementary)

1. Check inverter directional switch (1) is in central "0" position and that power is available to the inverter.
2. Switch on the inverter using the built-in isolator switch and check no errors are displayed on screen. (2)
3. Directional switch governs which direction the pump will turn. When set to the right position, the pump should turn clockwise. (if not, refer to → 4.3 Connecting to the Power Supply)
4. Speed dial allows governance over pump rotor speed, between a minimum and a maximum set by the manufacturer. A speed of 0 RPM is achieved by setting directional by setting directional switch to zero.

## Note

The pump will still turn when the speed dial is set to the minimum position.

5. The display can show motor parameters such as power consumption (kW), current draw (A) and speed (4). The custom parameter "C" shows nominal flow rate of the pump. To switch between which parameter is displayed, press hexagonal button for <1s and repeat until desired parameter is displayed. (5)
6. Additional control methods can be programmed if desired, e.g. modbus/4-20mA control. Refer to the included Invertek manual and consult your local Invertek supplier for guidance on how to do this.

**Specific parameters which if changed will void Verderflex warranty, so consult with Verder distributor before changing parameters.**

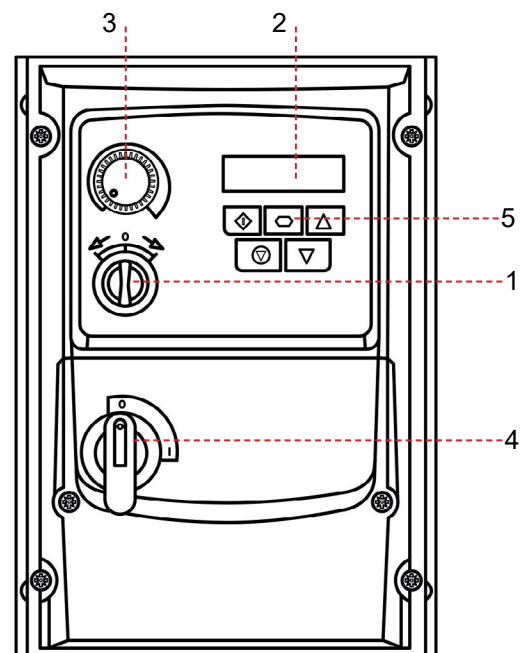



Figure 3 iDura Inverter Overview

## 6 Maintenance

 Only trained service technicians should be employed for fitting and repair work. Present a pumped medium certificate (DIN safety data sheet or safety certificate) when requesting service.

### 6.1 Hose Change

#### WARNING

##### Risk of injury!

- ▶ Always isolate the power supply before working on the pump.
- ▶ If inspection cover is removed for cleaning the pump cavity, isolate the inverter until inspection cover is replaced.

 The hose change involves removal and re-installing the port flanges. Disconnect inlet and outlet pipework. Clear the area to provide safe working space and clearance to replace the hose.

#### 6.1.1 Draining Lubricant

Checklist:

- Motor isolated.
- System secured against being switched back on again.

#### WARNING

##### Slip hazard due to spilt lubricant!

- ▶ Care must be taken when lubricant is drained into a container.
- ▶ Dispose of used lubricant in accordance with local laws and good environmental practices.

1. Remove the drain plug at the rear of the pump.
2. Drain the lubricant into a suitable container.
3. Remove the lower flange and allow any excess lubricant to drain out.

#### 6.1.2 Hose Change Using Inverter

#### CAUTION

##### Risk of injury if the hose is expelled too quickly!

- ▶ Keep body parts clear of the rotor which presents an entrapment risk.
- ▶ Set speed dial to minimum position. Disable and disconnect any remote control that has been programmed into the inverter.
- ▶ Slowly remove the hose by using the inverter to turn the pump at low speed.

1. Remove both the flanges. Remove and dispose of both clamp rings (where fitted).

2. Set directional dial to whichever direction is preferable, and the speed dial to minimum setting.
3. The motor will slowly drive out the hose. If at this point you are performing inspection on the rotor or pump cavity, turn off inverter and lock-out using an appropriate lock-out-tag-out.
4. Clean the pump housing.
5. Inspect the flanges for damage and signs of wear.

#### 6.1.3 Hose Change Manually

#### CAUTION

##### Risk of injury if the hose is expelled too quickly!

- ▶ When performing a hose change manually, turn directional switch on inverter to central "0" position, power off and lock out the inverter using the isolator switch. Allow 10 minutes for internal circuits to de-energise.

1. Remove both the flanges. Remove and dispose of both clamp rings (where fitted).
2. Remove the fan cover and turn the fan shaft by hand or using suitable leverage. Care must be taken not to damage the fan blades when using this method.
3. Clean the pump housing.
4. Inspect the flanges for damage and signs of wear.

#### 6.1.4 Re-installing the Hose, Port Flanges, Lubricant Refill and Fitting the Inspection Window

1. Apply lubricant to new hose surface and insert into the pump inlet.
2. When the hose is installed by **using the inverter** controls in the opposite direction will turn the rotor to drive the hose into the pump.
3. When the hose is installed **manually**, turn motor cooling fan in opposite direction to drive the hose into the pump.

#### CAUTION

Ensure the hose is installed as indicated in the Dura 05-35 operating manual, section 5.6 Flange Assembly.

4. Follow step by step the instructions listed in Dura 05-35 operating manual for how to install the port flanges, refill the lubricant and fit the inspection window.

## 7 Service and Inspection of Electrical Components



It is understood that electrical components must be periodically inspected to ensure site health and safety regulations. Only a trained electrician should service the pump's electrical components. When doing so, ensure the following:

1. Power to the inverter is disconnected and locked out
2. The inverter has been turned off and locked out
3. The speed dial is set to minimum and directional dial is set to zero
4. The inverter has been allowed at least 10 minutes to de-energise.

## 8 Troubleshooting for the iDura (Inverter Range)



A comprehensive list of error messages and their causes can be found in the Invertek OptiDrive E3 operation manual.

Below are the typical troubleshooting error messages that may be received based on Verder factory settings and relate to the pump configuration:

1. **"E-TriP"** - the hose burst sensor has been triggered. Check for a hose burst.
2. **"l\_t\_trP"** - suspected motor overtemperature. Allow motor to cool and restart inverter.

### 8.1 Hose Burst Detection and Vent Kit



Hose burst sensor supplied as standard with the iDura, have been pre-wired to the inverter. No further wiring has to be done by the user to use the hose burst detection.

Verderflex hose burst detector and vent kit provide three basic functions:

1. Stops the pump in conjunction with the inverter, in case of accidental hose burst;
2. Detect over pressure inside the pump;
3. Release excess pressure from pump housing

The calibrated sensor detects any increase in the pressure inside a pump casing. As the pressure threshold is reached, the sensor changes state and this can be used to turn-off the pump. The system has a detection threshold of 0.4 Bar (5.8 P.S.I) and when the casing pressure exceeds this, it initiate triggers the inverter to stop the pump. In the event of a pressure rise inside the pump casing exceeding 2bar, the vent kit helps to release this excess pressure from the pump.

## 8.2 iDura Inverter Functionality

 Values set during assembly at Verder should not be changed. These have been determined to be specific to the selected hardware. Some functionality in the inverter can be set by the customer to make it work with their system and control method, though the following parameters should not be changed and will result in warranty being voided if changed:

Parameter	Description	User can change?
1	Maximum speed/frequency limit	No
2	Minimum speed/frequency limit	No
3	Acceleration ramp time	Yes
4	Deceleration ramp time	Yes
5	Stopping mode/mains loss response	Yes
6	Energy optimiser	No
7	Motor rated voltage DELTA/STAR	No
8	Motor rated current DELTA/STAR	No
9	Motor rated frequency	No
10	Motor rated speed	No
11	Low frequency torque boost	No
12	Primary command source	Yes
13	Operating mode select	No
14	Extended/Advanced menu access code	Yes
15	Digital input function select	Yes
16	Analog input 1 signal format	Yes
17	Maximum effective switching frequency	No
18	Output relay function select	Yes
19	Relay threshold level	Yes
20	Speed 1	Yes
21	Speed 2	Yes
22	Speed 3	Yes
23	Speed 4	Yes
24	2nd ramp time (fast stop)	Yes
25	Analogue output function select	Yes
26	Skip frequency hysteresis band	Yes
27	Skip frequency centre point	Yes
28	V/F characteristic adjustment voltage	No
29	V/F characteristic adjustment frequency	No
30	Start mode, automatic restart, fire mode operation	Yes
31	Keypad start mode select	No
32	DC injection mode and duration	No
33	Spin start	Yes
34	Brake chopper enable (not size 1)	No
35	Analog input 1 scaling/slave speed scaling	Yes

Table 4 iDura Inverter Parameters (continued)

## 8.2 iDura Inverter Functionality (continued)

Parameter	Description	User can change?
36	Serial communications configuration	Yes
37	Access code definition	Yes*
38	Parameter access lock	Yes
39	Analog input 1 offset	Yes
40	Display scaling	No
41	PI controller proportional gain	Yes
42	PI controller integral time	Yes
43	PI controller operating mode	Yes
44	PI reference source select	Yes
49	PI control wake up error level	No
50	User output relay hysteresis	Yes
51	Motor control mode	Yes
52	Motor parameter autotune	Yes
53	Vector mode gain	No
54	Max current limit in vector control	No
55	Motor stator resistance	No
56	Motor stator d-axis inductance	No
57	Motor stator q-axis inductance	No
58	DC injection speed	No
59	DC injection current	No
60	Motor overload management	Yes

Table 4 iDura Inverter Parameters (continued)

## 9 List of Figures and Tables

### 9.1 List of Figures

Figure 1	Fastening Lifting Gear to Pump	3.1.2
Figure 2	Wiring Diagram - Single and 3 Phases Supply	4.3
Figure 3	iDura Inverter Overview	5

### 9.2 List of Tables

Table 1	Target Groups	1.1
Table 2	Warnings Used in the Manual	1.2
Table 3	Symbols Used in the Manual	1.2
Table 4	iDura Inverter Parameters	8.2
Table 5	Declaration of Conformity	10

## 10 EC Declaration of Conformity



<p><b>EC declaration of conformity according to machinery directive, appendix II A</b></p> <p>We,                  VERDER Ltd., Unit 3 California Drive, Castleford                  hereby declare that the following machine adheres to the relevant EC directives detailed below</p> <p>Designation    <b>iDura MK IV 05</b>                                    <b>iDura MK IV 07</b>                                    <b>iDura MK III 10</b>                                    <b>iDura MK III 15</b>                                    <b>iDura MK III 25</b>                                    <b>iDura MK III 35</b></p> <p>EC directives:</p> <ul style="list-style-type: none"> <li>• Machinery Directive (2006/42/EC)</li> <li>• Low-voltage directive (2014/35/EU)</li> <li>• EMC directive (2014/30/EU)</li> <li>• RoHS Directive (2011/65/EU) and Delegated Directive (EU) 2015/863</li> </ul> <p>Applicable harmonized norms:</p> <ul style="list-style-type: none"> <li>• EN ISO 12100: 2010</li> </ul>		
<p><b>Manufacturer</b></p>	<p>VERDER Ltd.                  Unit 3 California Drive                  Castleford                  WF10 5QH                  UK</p>	
<p><b>Date: 01/ 11/ 2020</b></p>	<p><b>Company Stamp / Signature:</b></p>  <p><b>Anthony Beckwith</b>                  Head of Development/Construction</p>	<p><b>Company Stamp / Signature:</b></p>  <p><b>Paul Storr</b>                  Head of Quality</p>

Table 5 Declaration of Conformity

## Appendix - iDura 05-35

### 11 Technical Specifications

#### 11.1 Pump Specifications

Size	Value	
Max. delivery pressure	iDura 5-7	5 bar
	iDura 10-25	6 bar
	iDura 35	6 bar
Temperature of pumped liquid	< 100 °C (subject to hose material)	
Max. continuous operation pump speeds	*(refer pump datasheet)	
Dimensions	*(refer pump datasheet)	

Table 1 Pump Specifications

#### 11.2 Ambient Conditions

 Operation under any other ambient condition would require approval from the manufacturer

##### Operating conditions

- Ambient temperature -5 °C to +40 °C
- Relative humidity (non-condensing) – long-term ≤ 85 %
- Setup height above sea level ≤ 1000 m

##### Storage conditions

- Ambient temperature +10 °C to +50 °C
- Relative humidity (non-condensing) – long-term ≤ 85 %

#### 11.3 Tightening Torques

 Following tightening torques should be applied in conjunction with pump tightening torques indicated in pump manual

Position	Torque Values (Nm)			
	iD5,7,10	iD15	iD25	iD35
Motor foot bolts	7		16	
Motor plate bolts	12		27	54
Inverter mount bolts	1			
Inverter terminal panel	2			
Inverter power terminals	1.5			
Inverter control terminals	0.5			
Cable glands/locknuts	3.5			
Motor terminals	2			
Gland reducer	N/A			35

Table 2 Tightening Torques

#### 11.4 Preservatives

 Use RUST-BAN 335 or similar preservatives on bare metal.

#### 11.5 Cleaning Agents (After hose is removed)

Cleaning Agents
Wax solvents, diesel paraffin, alkaline cleaners, Warm Water

Table 3 Cleaning Agents

#### Note

Depending on medium being pumped, please use suitable cleaning agent to neutralise any residue

#### 11.6 Lubricants

 Recommended lubricants for longer hose life are VERDERLUBE or VERDERSIL.

Pump Type	Amount of Lubricant
iDura 5	0.25 Ltrs (0.06 US Gallons)
iDura 7	0.25 Ltrs (0.06 US Gallons)
iDura 10	0.25 Ltrs (0.06 US Gallons)
iDura 15	0.50 Ltrs (0.13 US Gallons)
iDura 25	2.0 Ltrs (0.53 US Gallons)
iDura 35	2.5 Ltrs (0.66 US Gallons)

Table 4 Lubricant

#### Note

The pump lubricant is filled to the lowest screw hole of the inspection window.

#### 11.7 Rotor Options

 Verderflex iDura 5-35 range has only standard pressure rotor as follows:

Pump Type	Rotor Option (bars)
	Standard
iDura 5	5 bar
iDura 7	5 bar
iDura 10	6 bar
iDura 15	6 bar
iDura 25	6 bar.
iDura 35	6 bar

Table 5 Rotor Options



## 12 Trademarks

VERDERFLEX® is a registered trademark of Verder International B.V. No permission is granted to use any Verder, trademarks or trade names included in this document without the prior written agreement of Verder International B.V.

Modbus® is a registered trademark of Schneider electric USA, INC.

Tri-clamp® is a registered trademark of Alfa Laval Corporate AB.

Hypalon® is a registered trademark of RSCC Wire & Cable LLC.